

Brake Lines

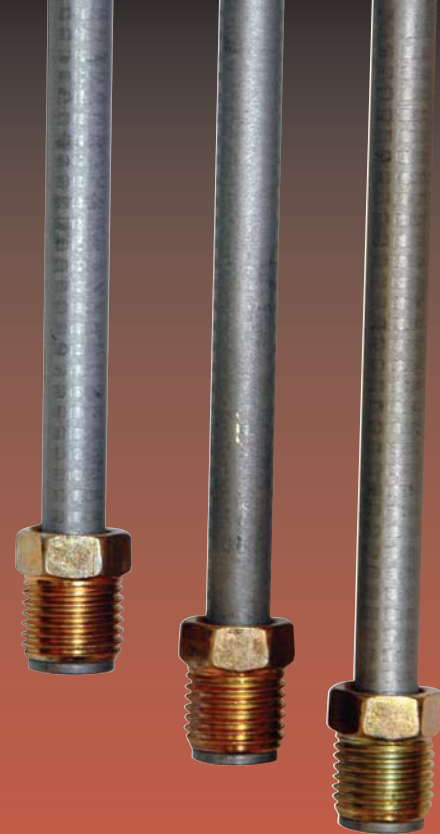

Domestic & Import Brake, Fuel & Transmission Line
Brake Line Fittings & Adapters
Assortments & Displays



JohnDow
DynamicTM
Automotive Fasteners & Supplies

Toll-Free
888-571-1141

www.dynamicautosupplies.com

Table of Contents

Adapter Brake Lines	5
Adapter Fittingn.	7
Bleeder Screws	8
Brake Fitting Kits	11-13
Brake Fittings - Retail	13
Brake Line Clamps	8
Brake Line Displays.	9 - 10
Brake Line	3 - 4
Coil Brake Line	4
Compression Fittings	8
Cross Reference.	14 - 15
Tube Nuts	6
Unions	8

Brake Line Coating

Dynamic offers three superior quality types of brake line - each offering excellent performance and corrosion resistance.

GALFAN® - is durable coating that helps resist abrasion and is a step above the many zinc coated brake lines on the market today.

It will not chip, soften or blister when exposed to corrosive fluids. ALGAL utilizes a hot dip coat of zinc aluminum alloy plus a thermoset aluminum rich epoxy top coat. It exceeds 2,000 hours of salt spray testing. ALGAL meets stringent auto industry requirements.

- Double-walled construction.
- Zinc coated.
- Aluminum epoxy top coat.

PVF - Polyvinylfluoride is a durable, highly abrasion resistant coating. It is another option for corrosion protection on double-wall brake lines.

This coating consists of a PVF topcoat that is painted and cured over an electroplated zinc substrate. PVF exceeds 2,000 hours of salt spray testing.

- Double-wall construction.
- Zinc coated.
- Polyvinylfluoride topcoat.
- Olive green color.

Copper-Nickel - is an alloy of 90% copper and 10% nickel which has a very high corrosion resistance. It out performs standard double-walled tubing.

Copper-Nickel is easy to bend and flare for trouble-free installation.

It provides superior reliability and durability for long-life functioning of the brake system.

Flare Types

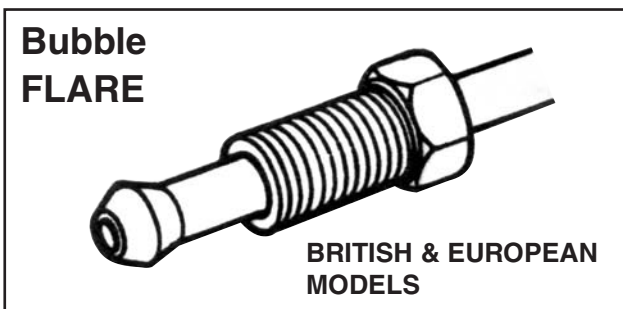
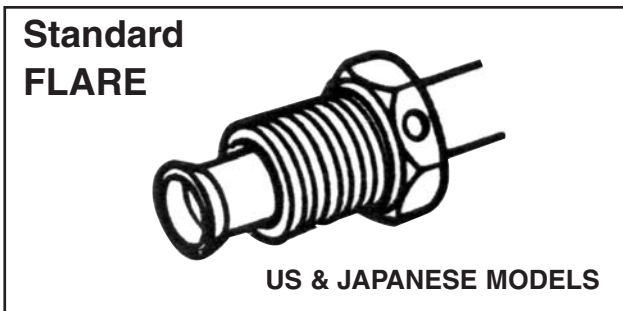

Domestic Steel Brake Lines

Galfan® Coated

PVF Coated

3/16" Domestic Steel Line - Standard Flare

Fittings: 105B & 105BL

Part No.	Description	Lines Per Tube	Part No.	Description	Lines Per Tube
BL-308	3/16" x 8"	10	PL-308	3/16" x 8"	10
BL-312	3/16" x 12"	10	PL-312	3/16" x 12"	10
BL-320	3/16" x 20"	10	PL-320	3/16" x 20"	10
BL-330	3/16" x 30"	10	PL-330	3/16" x 30"	10
BL-340	3/16" x 40"	10	PL-340	3/16" x 40"	10
BL-351	3/16" x 51"	10	PL-351	3/16" x 51"	10
BL-360	3/16" x 60"	10	PL-360	3/16" x 60"	10
BL-372	3/16" x 72"	10	PL-372	3/16" x 72"	10

1/4" Domestic Steel Line - Standard Flare

Fittings: 105C & 105CL

Part No.	Description	Lines Per Tube	Part No.	Description	Lines Per Tube
BL-408	1/4" x 8"	10	PL-408	1/4" x 8"	10
BL-412	1/4" x 12"	10	PL-412	1/4" x 12"	10
BL-420	1/4" x 20"	10	PL-420	1/4" x 20"	10
BL-430	1/4" x 30"	10	PL-430	1/4" x 30"	10
BL-440	1/4" x 40"	10	PL-440	1/4" x 40"	10
BL-451	1/4" x 51"	10	PL-451	1/4" x 51"	10
BL-460	1/4" x 60"	10	PL-460	1/4" x 60"	10
BL-472	1/4" x 72"	10	PL-472	1/4" x 72"	10

5/16" Domestic Steel Line - Standard Flare

Fittings: 105D

Part No.	Description	Lines Per Tube	Part No.	Description	Lines Per Tube
BL-508	5/16" x 8"	5	PL-508	5/16" x 8"	5
BL-512	5/16" x 12"	5	PL-512	5/16" x 12"	5
BL-520	5/16" x 20"	5	PL-520	5/16" x 20"	5
BL-530	5/16" x 30"	5	PL-530	5/16" x 30"	5
BL-540	5/16" x 40"	5	PL-540	5/16" x 40"	5
BL-551	5/16" x 51"	5	PL-551	5/16" x 51"	5
BL-560	5/16" x 60"	5	PL-560	5/16" x 60"	5
BL-572	5/16" x 72"	5	PL-572	5/16" x 72"	5

3/8" Domestic Steel Line - Standard Flare

Fittings: 105E

Part No.	Description	Lines Per Tube	Part No.	Description	Lines Per Tube
BL-608	3/8" x 8"	4	PL-608	3/8" x 8"	4
BL-612	3/8" x 12"	4	PL-612	3/8" x 12"	4
BL-620	3/8" x 20"	4	PL-620	3/8" x 20"	4
BL-630	3/8" x 30"	4	PL-630	3/8" x 30"	4
BL-640	3/8" x 40"	4	PL-640	3/8" x 40"	4
BL-651	3/8" x 51"	4	PL-651	3/8" x 51"	4
BL-660	3/8" x 60"	4	PL-660	3/8" x 60"	4
BL-672	3/8" x 72"	4	PL-672	3/8" x 72"	4

Import Steel Brake Lines

Galfan® Coated

PVF Coated

3/16" British Steel Line - Bubble Flare - 3/8-24

Fittings: 7800

Part No.	Description	Lines Per Tube	Part No.	Description	Lines Per Tube
ML-308	3/16" x 8"	5	PML-308	3/16" x 8"	5
ML-312	3/16" x 12"	5	PML-312	3/16" x 12"	5
ML-320	3/16" x 20"	5	PML-320	3/16" x 20"	5
ML-330	3/16" x 30"	5	PML-330	3/16" x 30"	5
ML-340	3/16" x 40"	5	PML-340	3/16" x 40"	5
ML-351	3/16" x 51"	5	PML-351	3/16" x 51"	5
ML-360	3/16" x 60"	5	PML-360	3/16" x 60"	5
ML-372	3/16" x 72"	5	PML-372	3/16" x 72"	5

3/16" European Steel Line - Bubble Flare - M10 x 1mm

Fittings: 7802

Part No.	Description	Lines Per Tube	Part No.	Description	Lines Per Tube
ML-3308	3/16" x 8"	5	PML-3308	3/16" x 8"	5
ML-3312	3/16" x 12"	5	PML-3312	3/16" x 12"	5
ML-3320	3/16" x 20"	5	PML-3320	3/16" x 20"	5
ML-3330	3/16" x 30"	5	PML-3330	3/16" x 30"	5
ML-3340	3/16" x 40"	5	PML-3340	3/16" x 40"	5
ML-3351	3/16" x 51"	5	PML-3351	3/16" x 51"	5
ML-3360	3/16" x 60"	5	PML-3360	3/16" x 60"	5
ML-3372	3/16" x 72"	5	PML-3372	3/16" x 72"	5

3/16" Japanese Steel Line - Standard Flare - M10 x 1mm

Fittings: 7801

Part No.	Description	Lines Per Tube	Part No.	Description	Lines Per Tube
ML-4308	3/16" x 8"	5	PML-4308	3/16" x 8"	5
ML-4312	3/16" x 12"	5	PML-4312	3/16" x 12"	5
ML-4320	3/16" x 20"	5	PML-4320	3/16" x 20"	5
ML-4330	3/16" x 30"	5	PML-4330	3/16" x 30"	5
ML-4340	3/16" x 40"	5	PML-4340	3/16" x 40"	5
ML-4351	3/16" x 51"	5	PML-4351	3/16" x 51"	5
ML-4360	3/16" x 60"	5	PML-4360	3/16" x 60"	5
ML-4372	3/16" x 72"	5	PML-44372	3/16" x 72"	5

Brake Line Coils

Galfan® Coated

PVF Coated

Part No.	Description	Coil Length	Part No.	Description	Coil Length
BL-316	3/16"	25'	PV-316	3/16"	25'
BL-414	1/4"	25'	PV-414	1/4"	25'
BL-516	5/16"	25'	PV-516	5/16"	25'
BL-638	3/8"	25'			

Copper Nickel

Part No.	Description	Coil Length
CN-316	3/16"	25'
CN-414	1/4"	25'

Adapter Brake Lines

3/16" Adapter Brake Lines - 8"

Part No.	Description	Qty Per Tube	Fitting (A) Size/Part No	Fitting (B) Size/Part No
BLA-101	1/4" Domestic to 3/16" Domestic	5	3/8-24 Inv (105B)	7/16-24 Inv (7955)
BLA-102	5/16" Domestic to 3/16" Domestic	5	3/8-24 Inv (105B)	1/2-20 Inv (____)
BLA-103	5/16" Domestic to 3/16" Domestic	5	3/8-24 Inv (105B)	1/2-20 Inv (7956)
BLA-105	9-16" Domestic to 3/16" Domestic	5	3/8-24 Inv (105B)	9/16-18 (7948)
BLA-107	European to 3/16" Domestic	5	3/8-24 Inv (105B)	M10 x 1.0 Bub (7801)
BLA-108	Japanese to Domestic	5	3/8-24 Inv (105B)	M10 x 1.0 Inv (7800)
BLA-109	Metric Bubble to Domestic	5	3/8-24 Inv (105B)	M11 x 1.5 Bulb (7945)
BLA-110	Metric Bubble to Domestic	5	3/8-24 Inv (105B)	M12 x 1/0 Bulb (7946)
BLA-111	Metric Bubble to Domestic	5	3/8-24 Inv (105B)	M13 x 1.5 Bulb (7947)
BLA-112	Metric Bubble to Metric Bubble	5	M10 x 1.0 Bub (7801)	M12 x 1.0 Bub (7946)

1/4" Adapter Brake Lines - 8"

BLA-104	9/16" Domestic to 1/4" Domestic	5	7/16-24 Inv (105C)	9/16-18 Inv (7958)
BLA-106	5/16" Domestic to 1/4" Domestic	5	7/16-24 Inv (105C)	1/2-20 Inv (7959)

6mm Adapter Brake Lines - 8"

BLA-113	Metric Bubble to 6mm	5	M12x1.0 Bub (7961)	M14 x 1.5 Bub (7963)
BLA-114	Metric Bubble to 6mm	5	M12x1.0 Bub (7961)	M12 x 1.5 Bub (7962)

Fittings Guide For Common Lines & Adapter Lines

Line	Type	Flare	Fitting A	Size	Fitting B	Size
Standard Lines						
3/16"	Domestic	Inv	105B	(3/8-24 Short)	105BL	(3/8-24 Long)
3/16"	British	Bub	7802	(3/8-24)	7802	(3/8-24)
3/16"	European	Bub	7801	(M10 x 1.0)	7801	(M10 x 1.0)
3/16"	Japanese	Inv	7800	(M10 x 1.0)	7800	(M10 x 1.0)
1/4"	Domestic	Inv	105C	(7/16-24 Short)	105CL	(7/16-24 Long)
5/16"	Domestic	Inv	105D	(1/2-20)	105D	(1/2-20)
3/8"	Domestic	Inv	105E	(5/8-18)	105E	(5/8-18)
Adapter Lines						
3/16"	Japanese to Domestic	Inv/Bub	105B	(3/8-24 Short)	7800	(M10 x 1.0)
3/16"	European to Domestic	Inv/Bub	105B	(3/8-24 Short)	7945	(M11 x 1.5)
3/16"	European to Domestic	Inv/Bub	105B	(3/8-24 Short)	7946	(M12 x 1.5)
3/16"	European to Domestic	Inv/Bub	105B	(3/8-24 Short)	7947	(M13 x 1.5)
3/16"	Dom 1/4" to Dom 3/16"	Inv/Inv	105B	(3/8-24 Short)	7955	(7/16-24)
3/16"	Dom 5/16" to Dom 3/16"	Inv/Inv	105B	(3/8-24 Short)	7956	(1/2-20)
3/16"	European to Domestic	Inv/Bub	105B	(3/8-24 Short)	7801	(M10 x 1.0)
3/16"	Dom 9/16" to Dom 3/16"	Inv/Inv	105B	(3/8-24 Short)	7948	(9/16-18)
1/4"	Dom 9/16" to Dom 1/4"	Inv/Inv	105C	(7/16-24 Short)	7958	(9/16-18)
1/4"	Dom 1/4" to Dom 1/4"	Inv/Inv	105C	(7/16-24 Short)	105C	(7/16-24 Short)
1/4"	Dom 5/16" to Dom 1/4"	Inv/Inv	105C	(7/16-24 Short)	7959	(1/2-20)
Fuel & Transmission Lines						
5/16"	Fuel and Transmission		105D	(1/2-20)	7953	(M14 x 1.5)
3/8"	Fuel and Transmission		105E	(5/8-18)	7954	(M16 x 1.5)

Tube Nuts









Part No.	Tube Size	Thread Size	Flare
 105B	3/16"	3/8"-24 Short	Inverted
 105BL	3/16"	3/8"-24 Long	Inverted
 105C	1/4"	7/16"-24 Short	Inverted
 105CL	1/4"	7/16"-24 Long	Inverted
 105D	5/16"	1/2"-20	Inverted
 105E	3/8"	5/8"-18	Inverted
 7800	3/16"	M10x1.0 (Jap)	Inverted
 7801	3/16"	M10x1.0 (Eur)	Bubble
 7802	3/16"	3/8"-24 (Brit)	Bubble
 7945	3/16"	M11x1.5	Bubble
 7946	3/16"	M12x1.0	Bubble
 7947	3/16"	M13x1.5	Bubble

Part No.	Tube Size	Thread Size	Flare
 7948	3/16"	9/16"-18	Inverted
 7950	3/16"	M12x1.0	Bubble
 7951	3/16"	M10x1.0 Long	Inverted
 7952	3/16"	M10x1.0	Bubble
 7955	3/16"	7/16"-24	Inverted
 7956	3/16"	1/2"-20	Inverted
 7957	3/16"	M10x1.0	Bubble
 7958	1/4"	9/16"-18	Inverted
 7959	1/4"	1/2"-20	Inverted
 7961	6mm	M12x1.0	Bubble
 7963	6mm	M14x1.5	Bubble

All Brake Fittings are Sold In Packages of 5

Adapter Fittings







	Part No.	Female Thread	Flare	Male Thread	Flare
	1441	3/8"-24	Inv	3/8"-24	Bub
	1442	3/8"-24	Inv	M10x1.0	Bub
	1443	3/8"-24	Inv	M10x1.0	Inv
	1445	3/8"-24	Inv	M11x1.5	Bub
	1446	3/8"-24	Inv	M12x1.0	Bub
	1447	3/8"-24	Inv	M13x1.5	Bub
	1448	3/8"-24	Inv	M10x1.25	Bub
	7727	1/2"-20	Inv	7/16"-24	Inv
	7818	3/8"-24	Inv	7/16"-24	Inv
	7828	7/16"-24	Inv	3/8"-24	Inv
	7829	7/16"-24	Inv	1/2"-20	Inv

	Part No.	Female Thread	Flare	Male Thread	Flare
	7908	7/16"-24	Inv	9/16"-18	Inv
	7909	3/8"-24	Inv	1/2"-20	Inv
	7910	3/8"-24	Inv	9/16"-20	Inv
	7911	3/8"-24	Inv	9/16"-18	Inv
	7912	9/16"-18	Inv	1/2"-20	Inv
	7913	1/2"-20	Inv	7/16"-24	Inv
	7915	5/8"-18	Inv	1/2"-20	Inv
	7916	1/2"-20	Inv	5/8"-18	Inv
	7935	M10x1.0	Inv	M11x1.5	Bub
	7936	M10x1.0	Inv	M12x1.0	Bub
	7937	M10x1.0	Inv	M13x1.5	Bub

All Brake Fittings are Sold In Packages of 5

Brake Line Fittings

Unions

Part No.	Tube Size	Thread Size	Flare
 300B	3/16"	3/8"-24	Inverted
 300C	1/4"	7/16"-24	Inverted
 300D	5/16"	1/2"-20	Inverted
 300E	3/8"	5/8"-18	Inverted
 1594	3/16"	3/8"-24 (Brit)	Bubble
 1595A	3/16"	M10x1.0 (Eur)	Bubble
 7934A	3/16"	M10x1.0 (Jap)	Inverted

Compression Unions



Not For Use With Braking Systems

Part No.	Tube Size	Thread Size	Flare
62A	1/8"	N/A	N/A
62B	3/16"	N/A	N/A
62C	1/4"	N/A	N/A
62D	5/16"	N/A	N/A
62E	3/8"	N/A	N/A

Brake Line Clamps (Stainless Steel)

Part No.	Tube Size	Description
BL-1B	3/16"	Brake Line Clamp 
BL-2B	1/4"	Brake Line Clamp
BL-3B	5/16"	Fuel Line Clamp
BL-1B	3/8"	Fuel Line Clamp

All Brake Fittings are Sold In Packages of 5

Bleeder Screws

Part No.	Thread Size	Length
 9400	3/8"-24	1.36
 9401	3/8"-24	1.47
 9402	3/8"-24	1.11
 9403	5/16"-24	1.06
 9404	1/4"-28	.92
 9405	M8x1.25	23.55mm
 9406	M10x1.5	27.5mm
 9407	M10x1.0	27.5mm
 9409	M10x1.0	32.75mm
 9410	M10x1.0	35.0mm
 9411	M7x1.0	32.0mm
 9412	M10x1.0	36.7mm
 9413	M7x1.0	38.55mm
 9415	7/16"-20	1.27
 9421	M10x1.25	33.1mm
 9422	M8x1.25	31.6mm
 9428	M8x1.25	35.5mm
 9430	M8x1.0	26.4mm
 Repair Insert 9442	1/4"-18 NPT	1-1/16
 Repair Insert 9443	7/16"-20 NPT	1-1/16
 Repair Insert 9444	1/8"-27NPT	31/32
 9450	Bleeder Screw Cap	
 Copper Washer 9451	I.D. 29/64" x O.D. 11/16"	
 Copper Washer 9452	I.D. 1/2" x O.D. 13/16"	
 Copper Washer 9453	I.D. 25/64" x O.D. 5/8"	
 Copper Washer 9454	I.D. 7/16" x O.D. 13/16"	

All Bleeder Screws are Sold In Packages of 10

Brake Line Displays & Assortments

Floor Display No. FBD-24

- Heavy-duty wire construction.
- Black powder-coat finish.
- Holds 24 tubes of brake line - 8" to 72" lengths.
- Includes line identification placard.

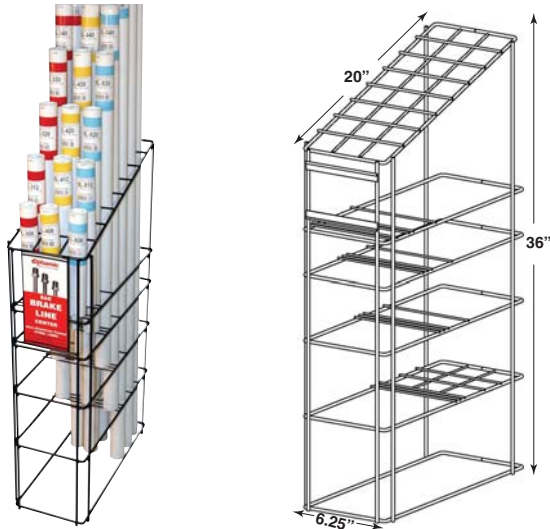

Wall Rack No. WBD-7

- Heavy-duty wire construction.
- Black powder-coat finish.
- Holds 7 lines - up to 10 lines per slot.
- Mounting tabs make easy wall installation.
- Includes line identification placard.



Part No.	Description	Coating	Assortment Type	No. Lines
FBD-24	Floor Display Merchandiser (No Lines)			
FDA-G	Floor Display Merchandiser	Galfan®	Domestic Assortment	200 Lines
FDA-P	Floor Display Merchandiser	PVF	Domestic Assortment	200 Lines
FDIA-G	Floor Display Merchandiser	Galfan®	Import Assortment	105 Lines
FDIA-P	Floor Display Merchandiser	PVF	Import Assortment	105 Lines
Part No.	Description	Coating	Assortment Type	No. Lines
WBD-7	Wall Display (No Lines)			
DG-316	Wall Display	Galfan®	3/16" Domestic Assortment	14 Lines
DG-140	Wall Display	Galfan®	1/4" Domestic Assortment	14 Lines
DG-516	Wall Display	Galfan®	5/16" Domestic Assortment	14 Lines
DG-638	Wall Display	Galfan®	3/8" Domestic Assortment	14 Lines
DP-316	Wall Display	PVF	3/16" Domestic Assortment	14 Lines
DP-140	Wall Display	PVF	1/4" Domestic Assortment	14 Lines
DP-516	Wall Display	PVF	5/16" Domestic Assortment	14 Lines
DP-638	Wall Display	PVF	3/8" Domestic Assortment	14 Lines
IG-B	Wall Display	Galfan®	British Assortment	14 Lines
IG-E	Wall Display	Galfan®	European Assortment	14 Lines
IG-J	Wall Display	Galfan®	Japanese Assortment	14 Lines
IP-B	Wall Display	PVF	British Assortment	14 Lines
IP-E	Wall Display	PVF	European Assortment	14 Lines
IP-J	Wall Display	PVF	Japanese Assortment	14 Lines

Floor Displays

Wall displays include lines and quantities (in tubes) listed below, one FBD-24 floor display and identification placard.

Domestic Assortment - Galfan®

3/16"		FDA-G 1/4"		5/16"	
BL-308	10	BL-408	10	BL-508	5
BL-312	10	BL-412	10	BL-512	5
BL-320	10	BL-420	10	BL-520	5
BL-330	10	BL-430	10	BL-530	5
BL-340	10	BL-440	10	BL-540	5
BL-351	10	BL-451	10	BL-551	5
BL-360	10	BL-460	10	BL-560	5
BL-372	10	BL-472	10	BL-572	5

Domestic Assortment - PVF

3/16"		FDA-P 1/4"		5/16"	
PL-308	10	PL-408	10	PL-508	5
PL-312	10	PL-412	10	PL-512	5
PL-320	10	PL-420	10	PL-520	5
PL-330	10	PL-430	10	PL-530	5
PL-340	10	PL-440	10	PL-540	5
PL-351	10	PL-451	10	PL-551	5
PL-360	10	PL-460	10	PL-560	5
PL-372	10	PL-472	10	PL-572	5

Import Assortment - Galfan®

British		FDIA-G European		Japanese	
ML-308	5	ML-3308	5	ML-4308	5
ML-312	5	ML-3312	5	ML-4312	5
ML-320	5	ML-3320	5	ML-4320	5
ML-330	5	ML-3330	5	ML-4330	5
ML-340	5	ML-3340	5	ML-4340	5
ML-351	5	ML-3351	5	ML-4351	5
ML-360	5	ML-3360	5	ML-4360	5

Import Assortment - PVF

British		FDIA-G European		Japanese	
PML-308	5	PML-3308	5	PML-4308	5
PML-312	5	PML-3312	5	PML-4312	5
PML-320	5	PML-3320	5	PML-4320	5
PML-330	5	PML-3350	5	PML-4330	5
PML-340	5	PML-3340	5	PML-4340	5
PML-351	5	PML-3351	5	PML-4351	5
PML-360	5	PML-3360	5	PML-4360	5

Wall Displays

Wall displays include lines and quantities listed below, one WBD-7 wall display rack and identification placard and size placard.

Domestic Assortment - Galfan®

DG-316 3/16"		DG-140 1/4"		DG-516 5/16"		DG-638 3/8"	
BL-308	2	BL-408	2	BL-508	2	BL-608	2
BL-312	2	BL-412	2	BL-512	2	BL-612	2
BL-320	2	BL-420	2	BL-520	2	BL-620	2
BL-330	2	BL-430	2	BL-530	2	BL-630	2
BL-340	2	BL-440	2	BL-540	2	BL-640	2
BL-351	2	BL-451	2	BL-551	2	BL-651	2
BL-360	2	BL-460	2	BL-560	2	BL-660	2

Domestic Assortment - PVF

DP-316 3/16"		DP-140 1/4"		DP-516 5/16"		DP-638 3/8"	
PL-308	2	PL-408	2	PL-508	2	PL-608	2
PL-312	2	PL-412	2	PL-512	2	PL-612	2
PL-320	2	PL-420	2	PL-520	2	PL-620	2
PL-330	2	PL-430	2	PL-530	2	PL-630	2
PL-340	2	PL-440	2	PL-540	2	PL-640	2
PL-351	2	PL-451	2	PL-551	2	PL-651	2
PL-360	2	PL-460	2	PL-560	2	PL-660	2

Import Assortment - Galfan®

British IG-B		European IG-E		Japanese IG-J	
ML-308	2	ML-3308	2	ML-4308	2
ML-312	2	ML-3312	2	ML-4312	2
ML-320	2	ML-3320	2	ML-4320	2
ML-330	2	ML-3330	2	ML-4330	2
ML-340	2	ML-3340	2	ML-4340	2
ML-351	2	ML-3351	2	ML-4351	2
ML-360	2	ML-3360	2	ML-4360	2

Import Assortment - PVF

British IP-B		European IP-E		Japanese IP-J	
PML-308	2	PML-3308	2	PML-4308	2
PML-312	2	PML-3312	2	PML-4312	2
PML-320	2	PML-3320	2	PML-4320	2
PML-330	2	PML-3330	2	PML-4330	2
PML-340	2	PML-3340	2	PML-4340	2
PML-351	2	PML-3351	2	PML-4351	2
PML-360	2	PML-3360	2	PML-4360	2

Brake Fitting Assortments

Dynamic Brake Fitting Assortments make it easy for any repair shop to keep the most popular fittings on-hand and organized. They save time and increase productivity by having the part available when needed.

Each assortment comes in a see-through plastic organizer box. Inside each lid is a plan-o-gram that makes identifying and reordering the part fast and easy.



No. BLF-1 Brake Line Fittings Assortment

General assortment of tube nuts and unions. Fittings include applications for British, European, and Japanese systems. 14 part numbers and 64 pcs.

BLF-1					
Brake Line Fittings					
Tube Nuts-Unions SAE & Metric					
105B Tube Nut 3/16 x 3/8-24 Inv	105BL Tube Nut—Long 3/16 x 3/8-24 Inv	105C Tube Nut 1/4 x 7/16-24 Inv	105CL Tube Nut—Long 1/4 x 7/16-24 Inv	105D Tube Nut 5/16 x 1/2-20 Inv	7800 Tube Nut (Japanese) 3/16 x M10 x 1.0 Inv
7801 Tube Nut (European) 3/16 x M10 x 1.0 Bub	7802 Tube Nut (British) 3/16 x 3/8-24 Bub	300B Union 3/16 x 3/8-24 Inv	300C Union 1/4 x 7/16 Inv	300D Union 5/16 x 1/2-20 Inv	1594 Union (British) 3/16 x 3/8-24 Bub
1595A Union (European) 3/16 x M10 x 1.0 Bub	7934A Union (Japanese) 3/16 x M10 x 1.0 Inv				

Part No.	Qty	Part No.	Qty
105B	.5	300D	.5
105BL	.5	1594	.3
105C	.5	1595A	.3
105CL	.5	7934A	.3
105D	.5	7800	.5
300B	.5	7801	.5
300C	.5	7802	.5

No. BLF-3 Brake Line Fittings Assortment

General assortment of tube nuts, unions and adapters. 19 part numbers and 95 pcs.

BLF-3					
Brake Line Fittings					
Tube Nuts Unions Adapters					
105B Tube Nut 3/16 x 3/8-24 Inv	105BL Tube Nut—Long 3/16 x 3/8-24 Inv	105C Tube Nut 1/4 x 7/16-24 Inv	105CL Tube Nut—Long 1/4 x 7/16-24 Inv	7800 Tube Nut (Japanese) 3/16 x M10 x 1.0 Inv	7801 Tube Nut (European) 3/16 x M10 x 1.0 Bub
7802 Tube Nut (British) 3/16 x 3/8-24 Bub	300B Union 3/16 x 3/8-24 Inv	300C Union 1/4 x 7/16 Inv	1594 Union (British) 3/16 x 3/8-24 Bub	1595A Union (European) 3/16 x M10 x 1.0 Bub	7934A Union (Japanese) 3/16 x M10 x 1.0 Inv
1441 Adapter 3/8-24 Inv to 3/8-24 Bub	1442 Adapter 3/8-24 Inv to M10 x 1.0 Bub	7818 Adapter 3/8-24 Inv to 7/16-24 Inv	7829 Adapter 7/16-24 Inv to 1/2-20 Inv	7908 Adapter 7/16-24 Inv to 8/18 Inv	7909 Adapter 3/8-24 Inv to 1/2-20 Inv
7910 Adapter 3/8-24 Inv to 9/16-20 Inv					

Part No.	Qty	Part No.	Qty
105B	.5	7934A	.5
105BL	.5	7800	.5
105C	.5	7801	.5
105CL	.5	7802	.5
300B	.5	7818	.5
300C	.5	7829	.5
1441	.5	7908	.5
1442	.5	7909	.5
1594	.5	7910	.5
1595A	.5		

No. BLF-4 Master Assortment (Tube Nuts & Unions)

Master assortment contains 20 different tube nuts and unions used to make most domestic and import brake lines. 91 pcs.

BLF-4					
Master Assortment					
Tube Nuts—Unions					
3/16" & 1/4"					
105B Tube Nut 3/16 x 3/8-24 Inv	105BL Tube Nut—Long 3/16 x 3/8-24 Inv	105C Tube Nut 1/4 x 7/16-24 Inv	105CL Tube Nut—Long 1/4 x 7/16-24 Inv	7800 Tube Nut (Japanese) 3/16 x M10 x 1.0 Inv	7801 Tube Nut (European) 3/16 x M10 x 1.0 Bub
7802 Tube Nut (British) 3/16 x 3/8-24 Bub	7945 Tube Nut 3/16 x M11 x 1.5 Bub	7946 Tube Nut 3/16 x M12 x 1.0 Bub	7947 Tube Nut 3/16 x M13 x 1.5 Bub	7948 Tube Nut 3/16 x 9/16-18 Inv	7950 Tube Nut 3/16 x M12 x 1.0 Bub
7951 Tube Nut—Long 3/16 x M10 x 1.0 Inv	7952 Tube Nut 3/16 x M10 x 1.0 Bub	7955 Tube Nut 3/16 x 7/16-24 Inv	7956 Tube Nut 3/16 x 1/2-20 Inv	7961 Tube Nut 6mm x M12 x 1.0 Bub	7962 Tube Nut 6mm x M12 x 1.5 Bub
7963 Tube Nut 6mm x M14 x 1.5 Bub	1595A Union (European) 3/16 x M10 x 1.0 Bub	7934A Union (Japanese) 3/16 x M10 x 1.0 Inv			

Part No.	Qty	Part No.	Qty
105B	.5	7946	.4
105BL	.5	7947	.4
105C	.5	7948	.4
105CL	.5	7950	.4
1595A	.5	7951	.4
7934A	.5	7952	.4
7800	.5	7955	.4
7801	.5	7956	.4
7802	.2	7961	.4
7945	.4	7963	.4

Brake Fitting Assortments

No. BA-1 Master Cylinder Adapter Assortment

For converting different sized port openings on master cylinders to standard brake systems. 11 part numbers and 53 pcs.

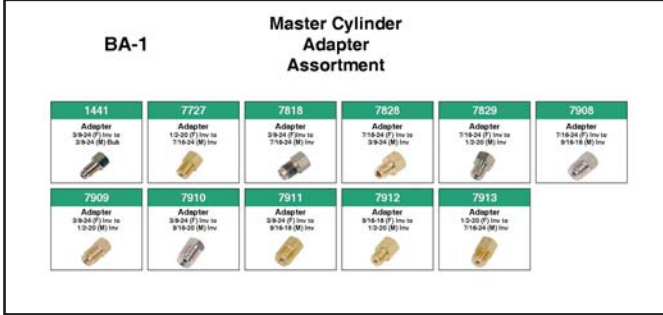

Part No.	Qty	Part No.	Qty
1441	.5	7909	.5
7727	.3	7910	.5
7818	.5	7911	.5
7828	.5	7912	.5
7829	.5	7913	.5
7908	.5		

No. BA-2 Metric Brake Line Adapter Assortment

For converting different sized port openings on master cylinders to standard brake systems. All metric sizes. 9 part numbers and 27 pcs.

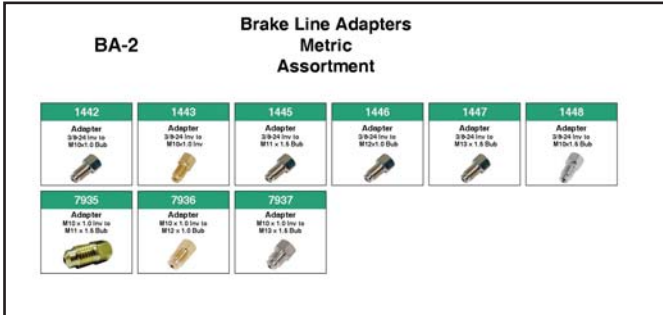

Part No.	Qty	Part No.	Qty
1442	.3	7935	.3
1443	.3	7936	.3
1445	.3	7937	.3
1446	.3		
1447	.3		
1448	.3		

No. BSA-1 Bleeder Screw Assortment

Most popular bleeder screws, repair inserts, copper washers and bleeder screw cap. 19 part numbers and 105 pcs.

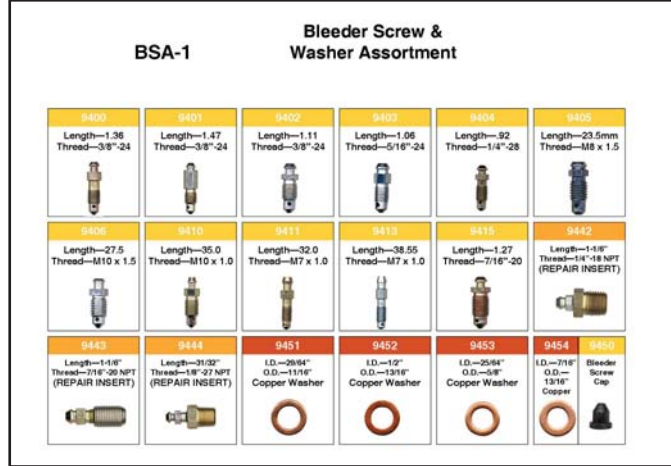

Part No.	Qty	Part No.	Qty
9400	.5	9442	.5
9401	.5	9443	.5
9402	.10	9444	.5
9403	.5	9450	.5
9404	.5	9451	.5
9405	.5	9452	.5
9406	.10	9453	.5
9410	.5	9454	.5
9411	.5		
9413	.5		
9415	.5		

No. BSA-2 Bleeder Screw Assortment

Most popular bleeder screws and washers. 10 part numbers and 30 pcs.

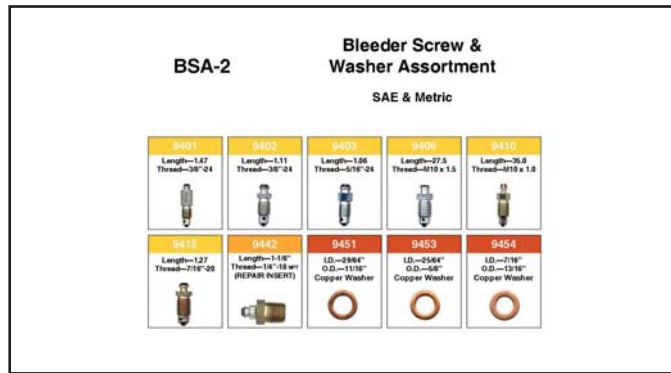

Part No.	Qty	Part No.	Qty
9401	.2	9415	.2
9402	.4	9442	.2
9403	.2	9451	.4
9406	.4	9453	.4
9410	.2	9454	.4

Master Brake Line Fittings Center No. BLF-34

The Dynamic BLF-34 Brake Fittings Center contains all of the popular fittings used for brake line repair and replacement. This assortment includes tube nuts for 3/16" and 1/4" brake line - SAE and Metric sizes, unions and master cylinder adapters.

- Essential for shops doing extensive brake line repair.
- Saves time - increases productivity and profitability.
- 360 pieces and 30 different part numbers.
- Packed in color coded boxes for easy identification.
Easy to reorder.
- Easy to keep organized.
- Includes a sturdy steel wall rack - measures 24"H x 13"W.

Assortment includes the following:

Part No.	Qty	Part No.	Qty	Part No.	Qty.
Tube Nuts		BC-7951	8	Adapters	
BC-105B	20	BC-7952	8	BC-1441	10
BC-105BL	10	BC-7955	8	BC-1442	10
BC-105C	10	BC-7956	8	BC-7818	10
BC-105CL	10	BC-7961	8	BC-7829	10
BC-7800	10	BC-7963	8	BC-7908	10
BC-7801	10			BC-7909	10
BC-7802	10	Unions		BC-7910	10
BC-7945	8	BC-1594	8		
BC-7946	8	BC-1595A	10		
BC-7947	8	BC-300B	5		
BC-7948	8	BC-300C	10		
BC-7950	8	BC-7934A	10		



Brake Fittings - Retail Packaging

Many of the popular fittings are available in clam shell packs for retail display and sale. Available fittings include tube nuts, unions and adapters.



Part No.	Qty	Part No.	Qty
Tube Nuts		1443-1	1
105B-2	2	1445-1	1
105B-5	5	1446-1	1
105C-2	2	1447-1	1
105D-2	2	7818-1	1
		7828-1	1
Unions		7829-1	1
300B-2	2	7908-1	1
300B-10	10	7909-1	1
300C-2	2	7910-1	1
300D-2	2	7911-1	1
300E-1	1	7912-1	1
1595A-1	1	7913-1	1
7934A	1	7915-1	1
		7916-1	1
Adapters		7935-1	1
1441-1	1	7936-1	1
1442-1	1	7937-1	1

DYN#	AGS	CORONET	EDELMANN	FMSI	NAPA
BL-308	BL-308	HL-3008	308ST	K-308	813-1201
BL-312	BL-312	HL-3012	312ST	K-312	813-1203
BL-320	BL-320	HL-3020	320ST	K-320	813-1204
BL-330	BL-330	HL-3030	330ST	K-330	813-1205
BL-340	BL-340	HL-3040	340ST	K-340	813-1206
BL-351	BL-351	HL-3051	351ST	K-351	813-1207
BL-360	BL-360	HL-3060	360ST	K-360	813-1208
BL-372	BL-372			K-372	813-1209
BL-408	BL-408	HL-4008	408ST	K-408	813-1226
BL-412	BL-412	HL-4012	412ST	K-412	813-1220
BL-420	BL-420	HL-4020	420ST	K-420	813-1221
BL-430	BL-430	HL-4030	430ST	K-430	813-1222
BL-440	BL-440	HL-4040	440ST	K-440	813-1223
BL-451	BL-451	HL-4051	451ST	K-451	813-1224
BL-460	BL-460	HL-4060	460ST	K-460	813-1225
BL-472	BL-472			K-472	813-1226
BL-508	BL-508	HL-5008	508ST	K-508	813-1236
BL-512	BL-512	HL-5012	512ST	K-512	813-1230
BL-520	BL-520	HL-5020	520ST	K-520	813-1231
BL-530	BL-530	HL-5030	530ST	K-530	813-1232
BL-540	BL-540	HL-5040	540ST	K-540	813-1233
BL-551	BL-551	HL-5051	551ST	K-551	813-1234
BL-560	BL-560	HL-5060	560ST	K-560	813-1235
BL-572	BL-572			K-572	813-1236
BL-608	BL-608	HL-6008	608ST	K-608	813-1246
BL-612	BL-612	HL-6012	612ST	K-612	813-1240
BL-620	BL-620	HL-6020	620ST	K-620	813-1241
BL-630	BL-630	HL-6030	630ST	K-630	813-1242
BL-640	BL-640	HL-6040	640ST	K-640	813-1243
BL-651	BL-651	HL-6051	651ST	K-651	813-1244
BL-660	BL-660	HL-6060	660ST	K-660	813-1245
BL-672	BL-672			K-672	813-124
ML-308	BLB-308	HL-3208	5308ST	KB-8	813-1250
ML-312	BLB-312	HL-3212	5312ST	KB-12	813-1251
ML-320	BLB-320	HL-3220	5320ST	KB-20	813-1252
ML-330	BLB-330	HL-3230	5330ST	KB-30	813-1253
ML-340	BLB-340	HL-3240	5340ST	KB-40	813-1254
ML-351	BLB-351	HL-3251	5351ST	KB-51	813-1255
ML-360	BLB-360	HL-3260	5360ST	KB-60	813-1256
ML-3308	BLE-308	HL-3108	6308ST	KMB-8	813-1260
ML-3312	BLE-312	HL-3112	6312ST	KMB-12	813-1261
ML-3320	BLE-320	HL-3120	6320ST	KMB-20	813-1262
ML-3330	BLE-330	HL-3130	6330ST	KMB-30	813-1263
ML-3340	BLE-340	HL-3140	6340ST	KMB-40	813-1264
ML-3351	BLE-351	HL-3150	6351ST	KMB-51	813-1265
ML-3360	BLE-360	HL-3160	6360ST	KMB-60	813-1266
ML-4308	BLJ-308	HL-3308	4308ST	KM-8	813-1270
ML-4312	BLJ-312	HL-3312	4312ST	KM-12	813-1271
ML-4320	BLJ-320	HL-3320	4320ST	KM-20	813-1272
ML-4330	BLJ-330	HL-3330	4330ST	KM-30	813-1273
ML-4340	BLJ-340	HL-3340	4340ST	KM-40	813-1274
ML-4351	BLJ-351	HL-3350	4351ST	KM-51	813-1275
ML-4360	BLJ-360	HL-3360	4360ST	KM-60	813-1276
PL-308	PA-308			PVF-308	813-5451
PL-312	PA-312			PVF-312	813-5452
PL-320	PA-320			PVF-320	813-5453
PL-330	PA-330			PVF-330	813-5454
PL-340	PA-340			PVF-340	813-8455
PL-351	PA-351			PVF-351	813-5456
PL-360	PA-360			PVF-360	813-5457
PL-372	PA-372			PVF-372	813-5458
PL-408	PA-408			PVF-408	
PL-412	PA-412			PVF-412	813-5459

DYN#	AGS	CORONET	EDELMANN	FMSI	NAPA
PL-420	PA-420			PVF-420	813-5460
PL-430	PA-430			PVF-430	813-5461
PL-440	PA-440			PVF-440	813-5462
PL-451	PA-451			PVF-451	813-5463
PL-460	PA-460			PVF-460	813-5464
PL-472	PA-472			PVF-472	
PL-508	PA-508			PVF-508	813-5465
PL-512	PA-512			PVF-512	813-5466
PL-520	PA-520			PVF-520	813-5467
PL-530	PA-530			PVF-530	813-5468
PL-540	PA-540			PVF-540	813-5469
PL-551	PA-551			PVF-551	813-5470
PL-560	PA-560			PVF-560	813-5471
PL-572	PA-572			PVF-572	
PL-608	PA-608			PVF-608	813-5474
PL-612	PA-612			PVF-612	813-5478
PL-620	PA-620			PVF-620	813-5479
PL-630	PA-630			PVF-630	813-5480
PL-640	PA-640			PVF-640	813-5481
PL-651	PA-651			PVF-651	813-5482
PL-660	PA-660			PVF-660	813-5483
PL-672	PA-672			PVF-672	813-5472
PML-308	PAB-308			PVFKB-8	813-5495
PML-312	PAB-312			PVFKB-12	813-5496
PML-320	PAB-320			PVFKB-20	813-5497
PML-330	PAB-330			PVFKB-30	813-5498
PML-340	PAB-340			PVFKB-40	813-5499
PML-351	PAB-351			PVFKB-51	813-5500
PML-360	PAB-360			PVFKB-60	813-5501
PML-3308	PAE-308			PVFKMB-8	813-5490
PML-3312	PAE-312			PVFKMB-12	813-5491
PML-3320	PAE-320			PVFKMB-20	813-5494
PML-3330	PAE-330			PVFKMB-30	813-5475
PML-3340	PAE-340			PVFKMB-40	813-5492
PML-3351	PAE-351			PVFKMB-51	813-5493
PML-3360	PAE-360			PVFKMB-60	813-5476
PML-4308	PAJ-308			PVFKM-8	813-5483
PML-4312	PAJ-312			PVFKM-12	813-5484
PML-4320	PAJ-320			PVFKM-20	813-5485
PML-4330	PAJ-330			PVFKM-30	813-5486
PML-4340	PAJ-340			PVFKM-40	813-5487
PML-4351	PAJ-351			PVFKM-51	813-5488
PML-4360	PAJ-360			PVFKM-60	813-5489
BL-316	BLC-325			C3	641-4000
BL-414	BLC-425			C4	641-4001
BL-516	BLC-525			C5	641-4002
BL-638	BLC-625			C6	641-4003
PBL-316	PAC-325			PVF-3	641-5473
PBL-414	PAC-425			PVF-4	641-5474
PBL-516	PAC-525			PVF-5	641-3344
PBL-638	PAC-625			PVF-6	641-3345
BLA-101	BLA-R340		318STA	913-002	813-1154
BLA-102	BLA-R350		328STA	913-004	813-1155
BLA-103	BLA-G360		338STA		813-1156
BLA-104	BLA-B410		418STA	913-005	813-1157
BLA-105	BLA-0370		348STA	913-006	813-1158
BLA-106	BLA-B440		438STA	3026416	813-1159
BLA-107				3028316	
BLA-108	BLA-0310			3043316	
BLA-109	BLA-Y311			3040316	
BLA-110	BLA-B312			3041316	
BLA-111	BLA-0313			3042316	
BLA-112				30283041	

Cross Reference

DYN#	AGS	CORONET	DORMAN	EDELMANN	FMSI	SUR&R	WEA HD
62A	CF-0B	62-2		162200			62X2
62B	CF-1B	62-3	490-22	162300	2855		62X3
62C	CF-2B	62-4	490-23	162400	2856		62X4
62D	CF-3B	62-5	490-24	162500	2857		62X5
62E	CF-4B	62-6	490-25	162600	2858		62X6
62F	CF-5B	62-8		162800			62X8
105B	BLF-12B	105-3S	490-296	121003	3000	BR-105	105X3
105BL	BLF-10B	105L-3	490-495	121030	3001	BR-135	7896X3
105C	BLF-13B	105-4S	490-297	121004	3003	BR-1150	105X4
105CL	BLF-16B	105L-4	490-496	121040	3004	BR-1400	7896X4
105D	BLF-14B	105-5S	490-298	121005	3006	BR-150	105X5
105E	BLF-15B	105-6S	490-299	121006	3015		105X5
300B	BLU-3B	300-3	490-330	123300	3002	BR-405	
300C	BLU-4B	300-4	490-331	123400	3005	BR-4100	302X4
300D	BLU-5B	300-5	490-332	123500	3007		302X5
300E	BLU-6B	300-6	490-333	123600	3018		302X6
702BB	BLF-59B	702-3	490-020	130333	3471		702X3
702C		702-4	490-070	130444	3472		702X4
702D				130555			702X5
702E				130666			702X6
1074				265500			1074
1441	BLF-30B		499-009	272330			1441
1442	BLF-31B		499-004	271300	3039	BR-505	7970
1443	BLF-29B		499-269	270300	3045	BR-500	1443
1445	BLF-32B		499-271	264000	3253		7973
1446	BLF-33B		499-273	265000	3252		7974
1447	BLF-34B		499-275	263000	3251		7972
1448			499-005	271330	3250		7976
1594	BLU-7B		499-211	275300	3047		1594
1595A	BLU-8B		499-251	276000	3044	BR-450	7975
7727				265401			7727
7732				265400	3029		7732
7800	BLF-40B				3043	BR-205	
7801	BLF-39B				3028	BR-230	
7802	BLF-38B				3410	BR-170	
7817							
7818	BLF-22B	210-34	490-534	258340	3232		7818
7828	BLF-23B	210-43	492-534	258430	3235		7828
7829	BLF-19B	210-45	490-537	258450	3233		7829
7897		210-35	499-003				
7908	BLF-25B	212-49	490-536	258403	3236		7908
7909	BLF-20B	210-35	490-535	258350	3230		7909
7910	BLF-27B	212-3920	490-531	258303	3231		7910
7911	BLF-28B	212-39	490-530	258302	3237		7911
7912	BLF-26B	212-38	490-532	258306			7912
7913	BLF-21B	212-3918	490-533	258307			7913
7914		914					
7915	BLF-18B	210-65		258650	3418		7915
7916	BLF-24B	210-56		258560	3419		7916
7917		210-54		258540			7917
7934A	BLU-9B	308-10	499-201	274000	3059	BR-435	7934A
7935	BLF-35B	301-11	499-266	266000	3473		7973
7935F							7942
7936	BLF-33B	301-12	499-267	267000	3474		7943
7937	BLF-34B	301-13	499-268	268000	3475		7944
7937F							7972
7938							
7939							
7940							
7941							
7942							
7943			490-710		3027	BR-210	
7945	BLF-47B		490-712		3040	BR-235	
7946	BLF-48B		490-713		3041	BR-240	
7947	BLF-49B		490-715		3042	BR-245	
7948	BLF-42B		490-303		3024	BR-155	
7950	BLF-46B				3413	BR-2200	
7951			490-711		3417	BR-270	
7952					3420		
7953	FLR-009B				3009		
7954	FLR-008B				3008		
7955			490-301		3022	BR-145	
7956	BLF-41B		490-302		3023	BR-150	
7957						BR-250	
7958	BLF-43				3025	BR-1600	
7959	BLF-44B				3026	BR-1650	
7961	BLF-51B				3421		
7963	BLF-53B				3423		
7981				265000			



**A Division of
JohnDow Industries, Inc.**

151 Snyder Avenue • Barberton, OH 44203

Toll-Free Phone: 800.433.0708

Fax: 330.753.6419

Web: www.dynamicautosupplies.com

Email: customerservice@johndow.com